

TEMPORARY WORK SITE LIGHTS INTEGRATED POWER CORD



super bright & durable



expansion outlet



built construction tough

- Available in 60W, 100W and 150W replacing up to 600W HID.
- Daisy-chain multiple lights together, up to 600W at 120V and 1200W at 277V.
- Each light comes with an integrated power cord (20' on 60W and 35' on other models) and expansion outlet.
- Integrated power cord eliminates need for extra extension cords.
- Metal cord retainer ensures the lights stay plugged in when daisy-chained together.
- Integrated carry handle/hanging hook with spring loaded lever allows for quick, secure hanging.
- High CRI with low power consumption for the most efficient work site.
- No bulbs or ballasts to replace.

STOCK ITEMS

PART #	UPC	REPLACES	WATTAGE	LUMENS	LPW	CCT (K)
LED-9006-50K	844006091033	250 HID	60W	6600	110	5000K
LED-9010-50K	844006091040	400 HID	100W	11000	110	5000K
LED-9015-50K	844006091057	600 HID	150W	16500	110	5000K



FOR PRODUCT INFO ("LED" MODEL #) CONTACT.....Light Efficient Design • 188 S. Northwest Highway • Cary, IL 60013 • 847.380.3540 • led-llc.com
 FOR PRODUCT INFO ("RP" MODEL #) CONTACT.....RemPhos by Light Efficient Design • 30 Log Bridge Road, Building 200 • Middleton, MA 01949 • 877.997.3674 • remphos.com

07.23.18 Information is subject to change without notice.

TEMPORARY WORK SITE LIGHTS INTEGRATED POWER CORD



LED-9006-60W

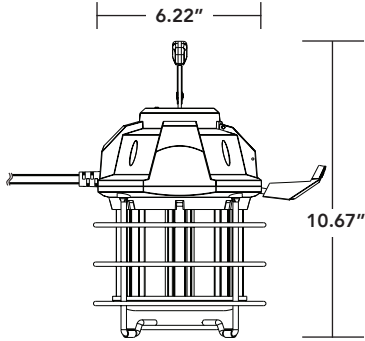

LED-9010-100W

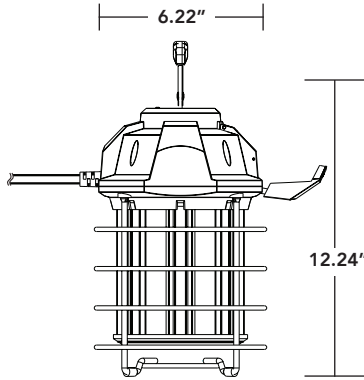

LED-9015-150W

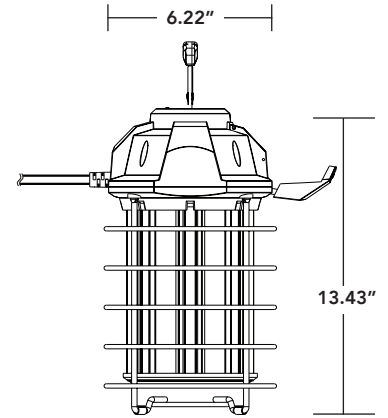

FOR PRODUCT INFO ("LED" MODEL #) CONTACT.....Light Efficient Design • 188 S. Northwest Highway • Cary, IL 60013 • 847.380.3540 • led-llc.com
FOR PRODUCT INFO ("RP" MODEL #) CONTACT.....RemPhos by Light Efficient Design • 30 Log Bridge Road, Building 200 • Middleton, MA 01949 • 877.997.3674 • remphos.com

07.23.18 Information is subject to change without notice.